

Upgrade the Extreme Management Center to ExtremeCloud IQ – Site Engine Air Gap Deployment

Quick Guide

Abstract: This document describes the necessary steps the admin should accomplish to upgrade the existing Extreme Management Center to the ExtremeCloud IQ – Site Engine in air gap deployment mode.

Published: May 2022

Extreme Networks, Inc.
145 Rio Robles
San Jose, California 95134
Phone / +1 408.579.2800
Toll-free / +1 888.257.3000
www.extremenetworks.com

© 2012–2021 Extreme Networks, Inc. All Rights Reserved.

AccessAdapt, Alpine, Altitude, BlackDiamond, Direct Attach, EPICenter, ExtremeWorks Essentials, Ethernet Everywhere, Extreme Enabled, Extreme Ethernet Everywhere, Extreme Networks, Extreme Standby Router Protocol, Extreme Turbodrives, Extreme Velocity, ExtremeWare, ExtremeWorks, ExtremeXOS, Go Purple Extreme Solution, ExtremeXOS ScreenPlay, ReachNXT, Ridgeline, Sentiariant, ServiceWatch, Summit, SummitStack, Triumph, Unified Access Architecture, Unified Access RF Manager, UniStack, XNV, the Extreme Networks logo, the Alpinelogo, the BlackDiamond logo, the Extreme Turbodrives logo, the Summit logos, and the Powered by ExtremeXOS logo are trademarks or registered trademarks of Extreme Networks, Inc. or its subsidiaries in the United States and/or other countries.

sFlow is the property of InMon Corporation.

Specifications are subject to change without notice.

All other registered trademarks, trademarks, and service marks are the property of their respective owners.

For additional information on Extreme Networks trademarks, see www.extremenetworks.com/company/legal/trademarks.

Table of Contents

Topics And Order Of Steps	3
Release Notes And Documentation	4
Convert the Extreme Management Center Licenses To Subscriptions.....	5
Downloading Upgrade Binaries of ExtremeCloud IQ – Site Engine And Components	6
Upgrade the Extreme Management Center To the Site Engine.....	8
Generate a License File at Extreme Portal.....	10
Upgrade ExtremeAnalytics & ExtremeControl Engines And Fabric Manager(s) And GIM(s)	12
Additional Resources	13

Topics And Order Of Steps

There are two deployment scenarios available for ExtremeCloud IQ – Site Engine starting version 21.11:

- Connected deployment mode:
 - Internet connectivity is required
 - ExtremeCloud IQ is a licensing authority
 - ExtremeCloud IQ – Site engine is integrated with ExtremeCloud IQ
- Air gap deployment mode:
 - Internet connectivity is not required
 - License file needs to be generated
 - Benefits of ExtremeCloud IQ are not available

There are the following steps:

- Read the Release Notes and related documentation.
- Convert the perpetual licenses to the subscription-based right to use. (The same procedure applies for Extreme Management Center subscriptions also).
- Download the upgrade binaries of ExtremeCloud IQ – Site Engine and components.
- Do not continue to the next steps without Pilot subscriptions.
- Upgrade the Extreme Management Center to the ExtremeCloud IQ – Site Engine.
- Generate the license file and insert it to the ExtremeCloud IQ – Site Engine.
- Upgrade ExtremeAnalytics & ExtremeControl engines and Fabric Manager(s) and GIM(s).

Release Notes And Documentation

- Read carefully the [Release Notes](#) there is a lot of important information.
- Check the new [licensing](#).
- Check what is ExtremeCloud IQ – Site Engine sending to ExtremeCloud IQ = [communication overview](#) in the connected deployment.
- Upgrade to ExtremeCloud IQ – Site Engine is supported from selected versions of Extreme Management Center and ExtremeCloud IQ – Site Engine. More details [here](#).
- Check the [Hardware](#) and [Operating System](#) requirements.
- Follow the [pre-installation checklist](#).

Convert the Extreme Management Center Licenses To Subscriptions

- ExtremeCloud IQ – Site Engine requires Pilot or Navigator subscriptions.
- Subscriptions are consumed through connection to ExtremeCloud IQ.
- Contact the local Extreme Networks representative to transition from support contract model to subscription model. Typically there is no additional cost for the transition. There is a procedure in place, you will be asked for:
 - Fill the form with details
 - Run the workflow to calculate the appropriate number of Pilot & Navigator licenses or export from the Extreme Management Center
 - Planned Upgrades or Expansion
 - Planned new Deployments and Hardware Refreshes
 - Existing service contracts (from the service team)
- The result is the appropriate number of Pilot & Navigator entitlements available through your Extreme Portal account.

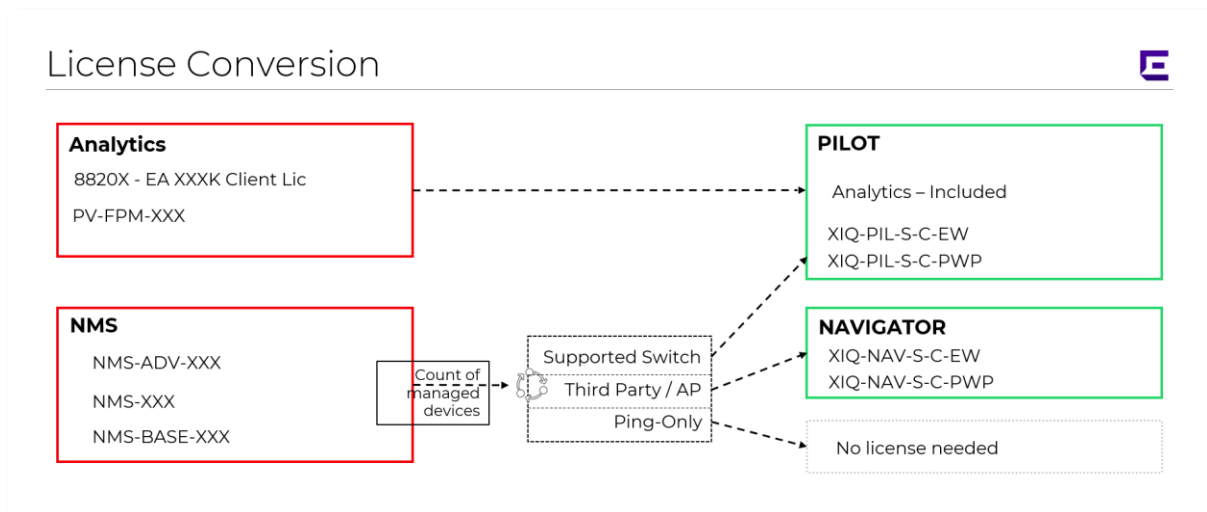

Downloading Upgrade Binaries of ExtremeCloud IQ – Site Engine And Components

1. Login to the [Extreme Portal](#)

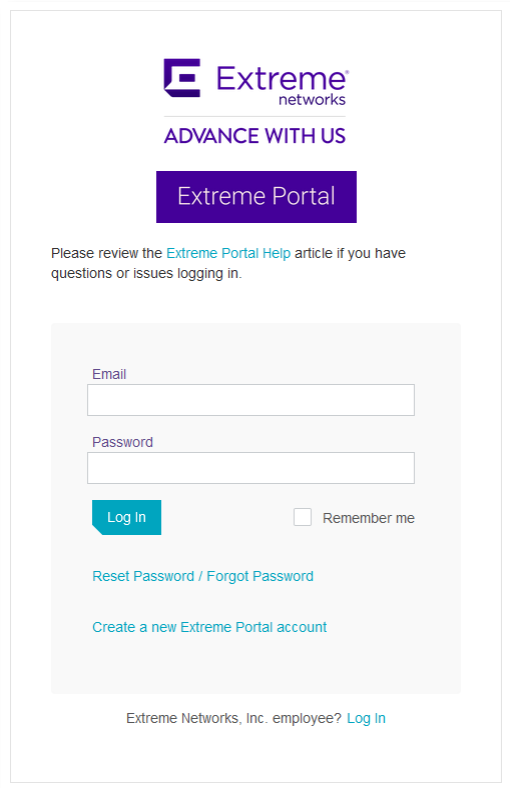

The screenshot shows the Extreme Networks Portal login interface. At the top, there is the Extreme Networks logo and the tagline "ADVANCE WITH US". Below this is a purple button labeled "Extreme Portal". A message reads: "Please review the [Extreme Portal Help](#) article if you have questions or issues logging in." The login form includes fields for "Email" and "Password", a "Log In" button, and a "Remember me" checkbox. There are also links for "Reset Password / Forgot Password" and "Create a new Extreme Portal account". At the bottom, it asks "Extreme Networks, Inc. employee?" with a "Log In" link.

2. Select Products -> ExtremeCloud -> ExtremeCloud IQ – Site Engine

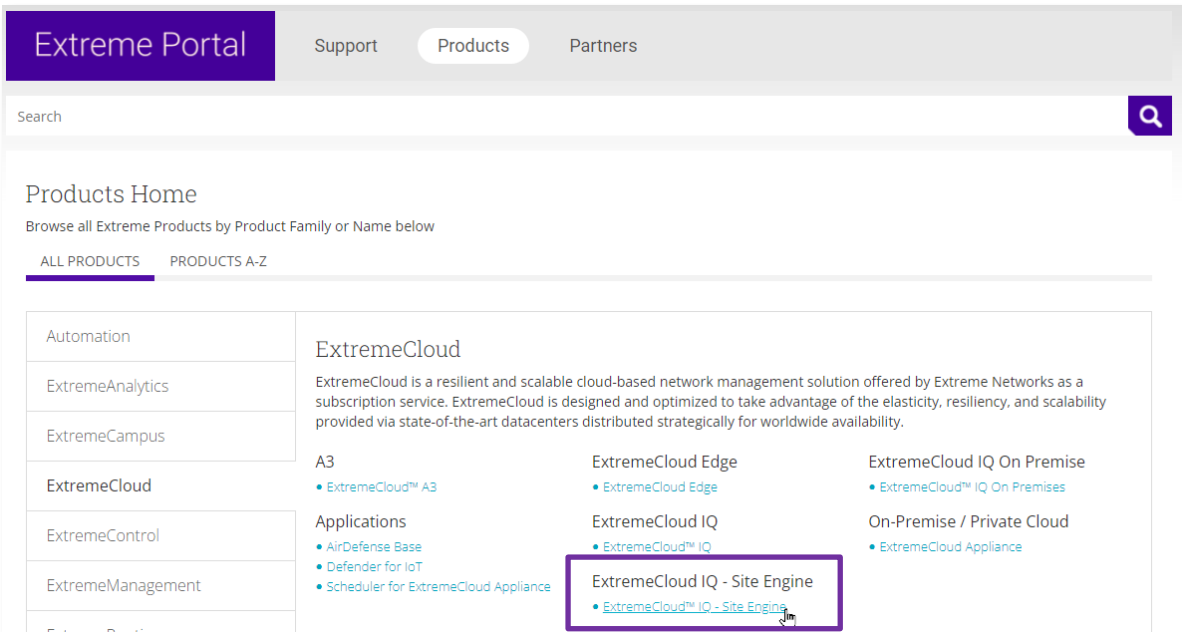

3. Select the version and the component (start with XIQ-SE)

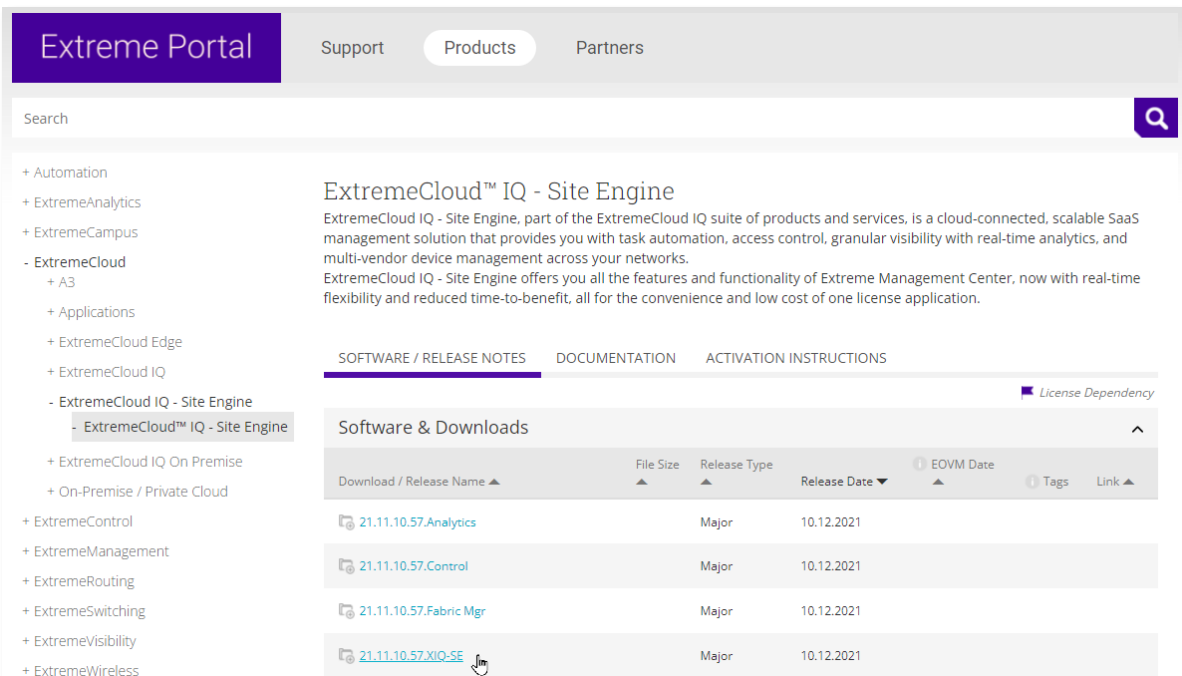

4. Download the upgrade BIN files

Upgrade the Extreme Management Center To the Site Engine

5. Make a **backup** of your Extreme Management Center.

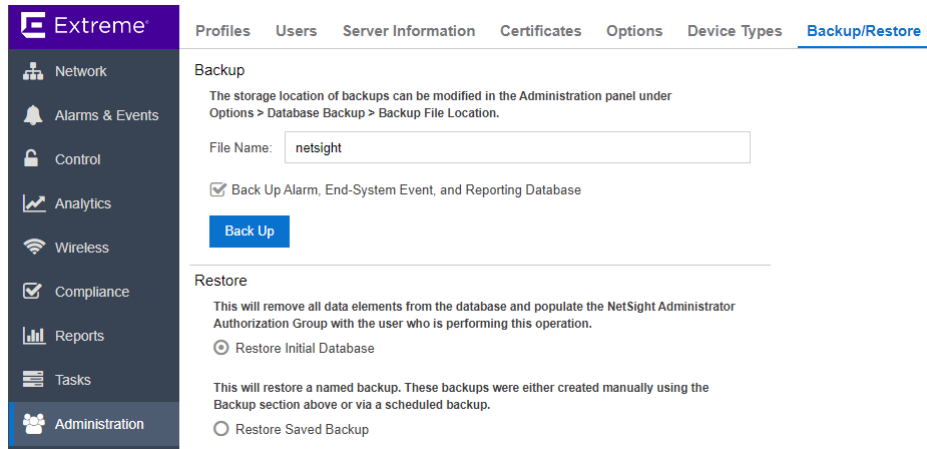

6. Upload the upgrade binary to the operating system (e.g. through SCP)
7. Change the permissions on the upgrade file by entering the following command:

```
chmod u+x ExtremeCloudIQSiteEngine_<version>_64bit_install.bin
```
8. Start the Installer.

```
./ExtremeCloudIQSiteEngine_<version>_64bit_install.bin
```
9. Answer questions required by the wizard.
10. Once the installation is completed navigate your web browser to **HTTPS://<IP-of-your-server>:8443** and login with your credentials.
11. Accept the License Agreement
12. Select: Enter entitlement(s) for air gapped ExtremeCloud IQ – Site Engine

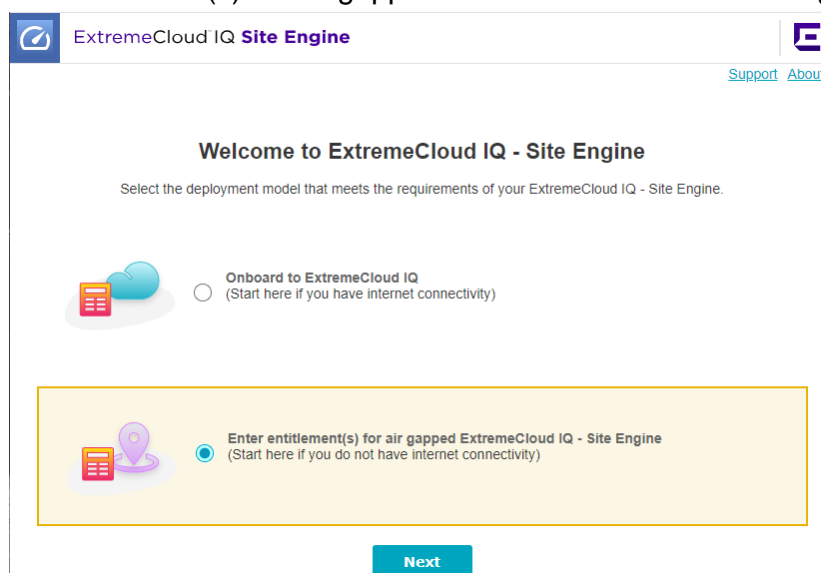

13. Copy the Serial Number (Locking ID)

Welcome to ExtremeCloud IQ - Site Engine

Air Gap License Entitlements

Enter the entitlement(s) for your air gapped ExtremeCloud IQ - Site Engine.
After adding entitlements to the table below, click the Continue button to log in to ExtremeCloud IQ - Site Engine.
ExtremeCloud IQ - Site Engine serial number (Locking ID, UUID): **XIQSE-88BE3E0218824A9C82211D9BD06AC199**
Don't have a license file? [Generate here](#)

Entitlements 📄

Drag and drop a license entitlement file into this zone or click here to paste license entitlements.

Feature	License Name	Type	Quantity	Start Date	End Date	Description
---------	--------------	------	----------	------------	----------	-------------

14. How to generate a license file is covered in the next chapter.

Generate a License File at Extreme Portal

15. Login to the [Extreme Portal](#), navigate Assets > Cloud Licenses Home > Generate License

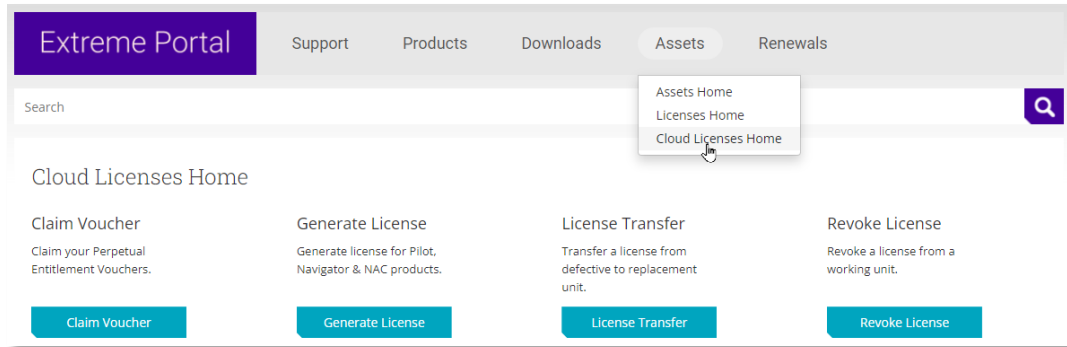

16. Fill the form and Submit

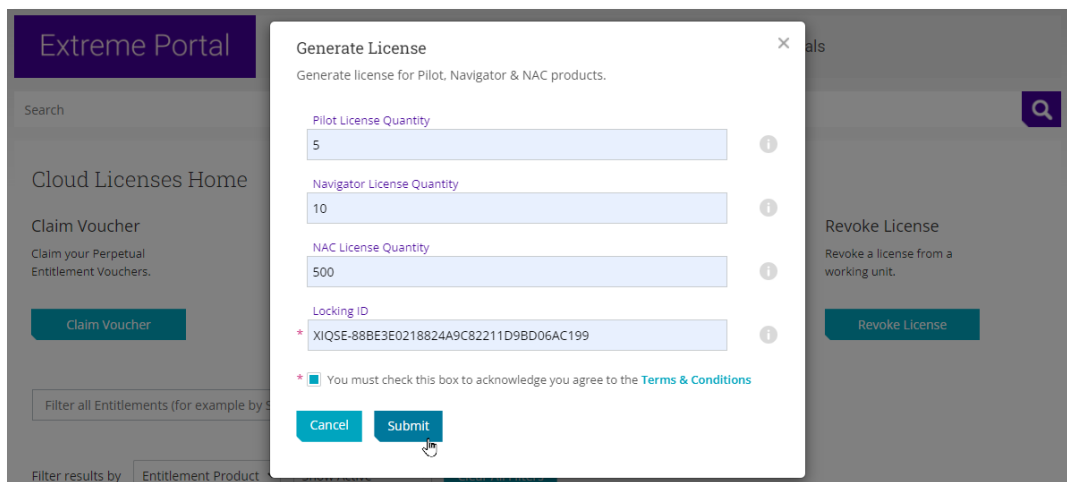

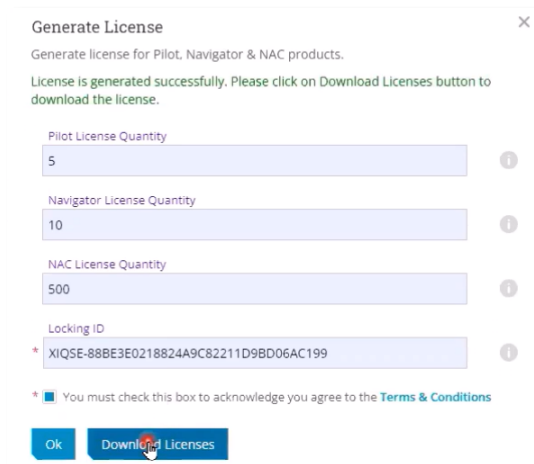

17. Download the license file



18. Return to the ExtremeCloud IQ – Site Engine and insert the license file.

Entitlements 

Drag and drop a license entitlement file into this zone or click here to paste license entitlements.

Feature	License Name	Type	Quantity	Start Date	End Date	Description	
PRD-XIQ-NAC-S	XIQ-NAC-S	Subscription	500	11/01/2021 01:00:00 AM	01/01/2022 12:59:00 AM	ExtremeCloud IQ - Site Engine - Access Control	
PRD-XIQ-PIL-S-C	XIQ-PIL-S-C	Subscription	5	11/01/2021 01:00:00 AM	01/01/2022 12:59:00 AM	ExtremeCloud IQ - Site Engine - Pilot	
PRD-XIQ-NAV-S-C	XIQ-NAV-S-C	Subscription	10	11/01/2021 01:00:00 AM	01/11/2022 12:59:00 AM	ExtremeCloud IQ - Site Engine - Navigator	

Displaying 3 rows

[Continue](#)

19. Multiple license files can be inserted one by one. Once all license files are inserted select Continue

Upgrade ExtremeAnalytics & ExtremeControl Engines And Fabric Manager(s) And GIM(s)

- Once the server is running the ExtremeCloud IQ – Site Engine, the ExtremeAnalytics Engine (Purview) needs to be upgraded. There are two options:
 - Upload the install binary to the ExtremeCloud IQ – Site Engine firmware repository and execute the upgrade of the Analytics Engine through the GUI. In this scenario, the SSH credentials must be configured and working.
 - Upload the install binary to the Analytics Engine and start the upgrade procedure through the console.
- The Access Control Engine upgrade procedure is similar to the Analytics Engine. There are two options:
 - Upload the install binary to the ExtremeCloud IQ – Site Engine firmware repository and execute the upgrade of the Control Engine through the GUI. In this scenario, the SSH credentials must be configured and working.
 - Upload the install binary to the Access Control Engine and start the [upgrade procedure](#) through the console.
- There are two options for the Fabric Manager upgrade procedure:
 - Upload the install binary to the ExtremeCloud IQ – Site Engine firmware repository and execute the upgrade of the Fabric Manager through the GUI. The Fabric Manager will be upgraded through the Cloud Connector.
 - Deploy and onboard the new Fabric Manager
- The GIM can be upgraded by deploying the new VM and connecting it to the Access Control Engines. The backup and restore feature of the GIM can be used.

Additional Resources

User Guide online:

<https://emc.extremenetworks.com/>

Firewall settings:

https://emc.extremenetworks.com/content/oneview/r_used_ports.html

Release Notes:

<https://www.extremenetworks.com/support/release-notes/>